

Künstliche Edelsteine (Forts.)

3. Verneuil-Verfahren \mapsto Rubin, Saphir (Korund)

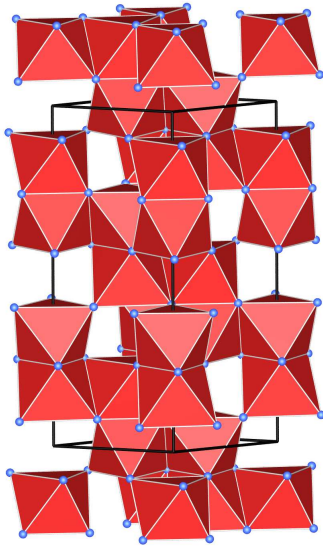

Struktur von Korund

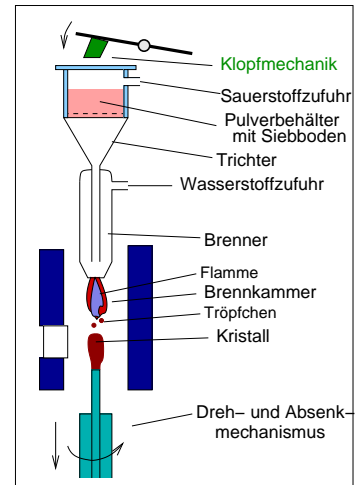
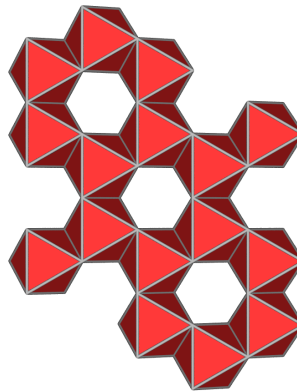

Verneuil-Verfahren

4. Czochralski-Verfahren \mapsto Granate (YAG usw.)

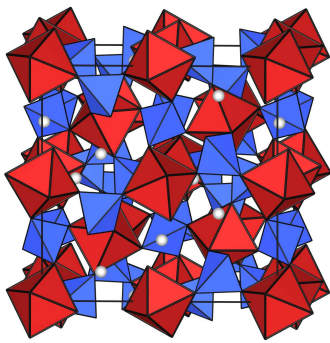

Struktur von Granat

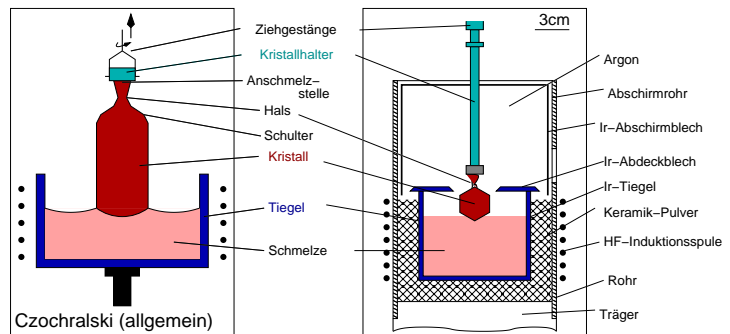

Czochralski-Verfahren (allgemein und für Granate)

5. Flux-Growth \mapsto Beryll (Smaragd, Aquamarin usw.)

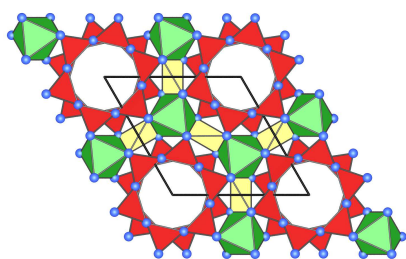

Struktur von Beryll

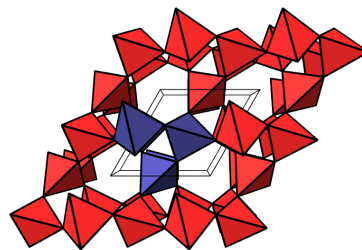

Struktur von α -Quarz

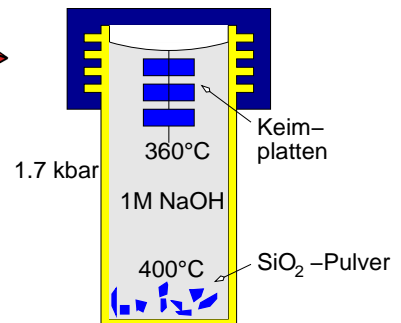

Hydrothermale Quarzsynthese

6. Hydrothermalsynthese \mapsto Quarz